



INSTALLATION GUIDE & USER MANUAL
FOR
ROOF AND GUTTER HEATING MATS

TEMPURTECH MFG. LLC
160 BENMONT AVE.
BENNINGTON, VT 05201

(802) 430-3617 | tempurtechsales@gmail.com | www.tempurtechmanufacturing.com

TABLE OF CONTENTS

WARNINGS FOR INSTALLATION AND USE.....	3
GENERAL PRODUCT INFORMATION.....	4
SPECIFICATIONS (GENERAL).....	4
SYSTEM COMPONENTS.....	6
TESTING YOUR SYSTEM.....	7
INSTALLATION.....	8
PREPARATION.....	8
GUIDELINES.....	9
SYSTEM LAYOUT.....	10
GUTTERS.....	12
ELECTRICAL.....	13
USER GUIDE.....	14
TROUBLESHOOTING.....	15



WARNINGS FOR INSTALLATION AND USE



THIS PRODUCT SHOULD ONLY BE INSTALLED BY COMPETENT PERSONNEL WHO ARE FAMILIAR WITH THE CONSTRUCTION AND OPERATION OF THE APPARATUS AND ANY RISKS INVOLVED. READ ALL INFORMATION PROVIDED IN THIS GUIDE BEFORE ATTEMPTING TO INSTALL THIS PRODUCT.



NEVER OVERLAP, LAYER, OR STACK HEATING MATS ON TOP OF ANOTHER PIECE OF HEATING MAT.



NEVER TRIM, CUT, OR OTHERWISE MODIFY THE DIMENSIONS OF YOUR HEATING MATS. CONTACT TEMPURTECH IF DIMENSIONS NEED TO BE MODIFIED.



DO NOT CONNECT HEATING MATS TO POWER UNTIL ALL NECESSARY ELECTRICAL CONNECTIONS HAVE BEEN COMPLETED AND INSULATED. ATTEMPTS TO CONNECT ENERGIZED CONDUCTORS WITHOUT PROPER INSULATION MAY RESULT IN ELECTRICAL SHOCK.



CHECK WITH YOUR ROOFING/GUTTER MANUFACTURER FOR MAXIMUM TEMPERATURE RATING. TEMPURTECH HEATED MATS REACH A MAXIMUM TEMPERATURE OF 120°F.



TO REMAIN COMPLIANT WITH THE NATIONAL ELECTRICAL CODE (NEC, ARTICLE 426 SECTION 28) ALL FIXED DEICING EQUIPMENT SHALL BE PROTECTED BY GROUND FAULT PROTECTION DEVICES. THIS IS A REQUIRED PART OF THE INSTALLATION PROCEDURE. HEATING MATS ARE TO BE INSTALLED ON OR CONNECTED TO A DEDICATED ELECTRICAL CIRCUIT(S), NOT TO EXCEED 80% OF THE BREAKER'S RATED CAPACITY.



ELECTRICAL WORK SHOULD BE PERFORMED ONLY BY COMPETENT PERSONNEL. FAILURE TO ADHERE MAY RESULT IN ELECTRICAL SHOCK AND PERSONAL INJURY.

THE DOCUMENTATION PROVIDED HEREIN PERTAINS SOLELY TO THE USE AND INSTALLATION OF TEMPURTECH HEATED ROOF MATS, TEMPURTECH HEATED GUTTER MATS, AND PRODUCTS PRODUCED BY TEMPURTECH MANUFACTURING LLC. SPECIFICATIONS ARE SUBJECT TO CHANGE.

GENERAL PRODUCT INFORMATION

- Please allow up to 20 minutes for mats to heat up. The mats WILL NOT feel hot to the touch and surface temperature will decrease with lower ambient temperatures. THIS IS NORMAL FOR OPERATION

- The installation of this heating product must be in accordance with both the manufacturer's instructions, and the regulations of the authority having jurisdiction. Failure to do so will result in a voided warranty.

- Caution must be taken to guard against risk of electrical shock, fire, and bodily injury

- The heating product must always be connected to a dedicated electrical circuit.

- The system shall be installed with a disconnecting means.

- The system should always be disconnected from its power source during service, this includes service to controllers and control panels.

- All systems MUST be installed with NEC compliant ground fault protection devices.

- The supply wire or terminals cannot be repaired. If the wire or terminal is damaged, it must be replaced.

SPECIFICATIONS (GENERAL)

HEATING MATS

PRODUCT	V**	COMPATIBLE WITH	CURRENT DRAW	POWER CONS.
5" WIDE	110	110V, 120V	~0.07 A/Ln ft.	~0.008kW/Ln ft.
12" WIDE	110	110V, 120V	~0.15 A/Ln ft.	~0.018kW/Ln ft.
12" WIDE	220	208V, 220V, 240V	~0.08 A/Ln ft.	~0.019kW/Ln ft.
24" WIDE	110	110V, 120V	~0.32 A/Ln ft.	~0.038kW/Ln ft.
24" WIDE	220	208V, 220V, 240V	~0.16 A/Ln ft.	~0.038kW/Ln ft.
CUSTOM	*	*	*	*

*Refer to the System Information packet produced with your specific system

**All power is single phase

SYSTEM CONTROLLER

PRODUCT	COMPATIBLE WITH	CIRCUIT CAPACITY	SWITCHING CAPACITY
ASE DS-9C	110 - 277V	2	30A

- Refer to "DS-9C User Manual" for more information

SPECIFICATIONS (GENERAL) CONT'D

SYSTEM CONTROL PANEL

PRODUCT	COMPATIBLE WITH	POWER REQ.	TEMP. RANGE
ASE CDP-2	ASE DS-9C CONTROLLER	CONTROLLER	-40°C - 85°C

- Refer to "CDP-2 User Manual" for more information

SYSTEM SPECIFICATIONS

Applications: For use on roofs and in gutters and downspouts for melting snow. and ice.

Voltage: 120V/1PH | 50/60Hz
240V/1PH | 50/60Hz

Power: ~18 W/sq ft.

**Maximum
Circuit Load:** 16 Amps

**Circuit
Overload
Protection:** (For max. circuit load) 20 Amp breaker with ground fault protection required for each circuit.

**Minimum Bend
Radius:** 1 inch at a 90 degree bend. Do not crease heating mat.

**Maximum
Element
Temperature:** 110°F/43°C (Sustained) 120°F/49°C (Absolute)

**Recommended
Installation
Temperature:** MAX: 150°F/65.5°C
MIN: -20°F/-29°C
Recommended >50°F/10°C for easiest installation.

TEMPURTECH MATS MAY BE INSTALLED WITH EITHER SIDE FACING UP



UNDER NO CIRCUMSTANCES SHOULD THE HEATING MATS BE ENERGIZED WHILE OVERLAPPED OR ROLLED UP. ENERGIZING THE MATS WHILE OVERLAPPED OR ROLLED UP MAY RESULT IN THE DESTRUCTION OF THE MATS AND/OR PERSONAL INJURY.

SYSTEM COMPONENTS



Tempurtech offers adjustable-threshold controllers to better automate your system based on weather and temperature conditions. Each controller includes an embedded temperature sensor and a remote moisture sensor. Each controller contains two single pole relays that operate simultaneously and control power to the mats, each having a switching capacity of 30 Amps. A controller may operate two circuits. Controllers should be mounted outdoors as close to the mats as possible and according to the "DS-9C User Manual" in order to best serve your system.



Tempurtech offers a control panel to indicate the status of the system and provide remote manual override options. Each controller may be paired with a control panel. Control panels should be mounted within sight and reach of system operator and according to the "CDP-2 User Manual" in order to best serve your system.



Tempurtech also offers double-sided adhesive tape for use with EPDM heating mats. The tape may be used to form a semi-permanent waterproof bond between the EPDM and application surface. If not already done, the tape may be applied to the mats by carefully peeling back the plastic film and pressing the tape firmly onto a clean mat. Do not peel back second side of film until the mats are ready for final placement.

REFER TO PAGE 7 AND RESPECTIVE USER MANUALS FOR COMPLETE
INSTALLATION INSTRUCTIONS.

TESTING YOUR SYSTEM

Tempurtech recommends testing all systems before final installation in order to ensure proper operation. If one or more mats fails to operate in the expected manner contact your Tempurtech Sales Representative (located on order invoice). Do not attempt to install malfunctioning heating mats.



ELECTRICAL WORK SHOULD BE PERFORMED ONLY BY COMPETENT PERSONNEL. FAILURE TO ADHERE MAY RESULT IN ELECTRICAL SHOCK AND PERSONAL INJURY

1. Using a multimeter or other resistance measuring device, test the resistance between the red and black leads of each section. The value should be close to that recorded in the 'TEST MEASUREMENTS' section of your Production Work Slip. **If the value is drastically different than the recorded value, DO NOT install the mats. Contact Tempurtech at the listed email address.**

2. Unroll all mats and connect each circuit directly to a power source compatible with your system (refer to page 4 or your system layout) and a correctly sized circuit breaker, rated for not less than 125% of the circuit current draw listed in "SYSTEM NOTES" in your layout. **IMPORTANT: Do not allow mats to overlap while energized.**

See Figures 1.1 & 1.2.

3. Wait 10-15 minutes for mats to completely heat up. Mats should reach a sustained temperature of 110°F-120°F in 60°F ambient temperature. This will feel warm to the touch. NOTE: If testing in colder temperatures, your mats may not feel warm. This is normal. A temperature measurement may need to be taken to confirm heating.

4. Inspect each mat individually and ensure that each is warming and is free of defects. Due to the self-regulating heating element, the mats will begin to cool upon placing your hand on the mat. This is normal for operation.

5. If each mat is reaching its rated sustained temperature, or the resistance measurements are correct, system testing is complete. Move on to installation.

120V SERVICE

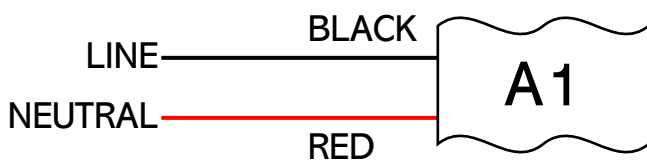

Figure 1.1: Connecting to 120V power

240V SERVICE

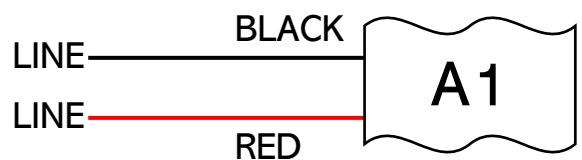

Figure 1.2: Connecting to 240V power

INSTALLATION - PREPARATION



AN INSUFFICIENTLY PREPARED SURFACE MAY LEAD TO MATS BECOMING DETACHED FROM SURFACE AND CAUSING DAMAGE TO BUILDING, PERSONNEL, OR MATS THEMSELVES.

1. Ensure roof, gutter, or other surface is structurally sound, installed correctly, and able to bear the complete weight of the mats.
2. Surface must be free of oily films and curing compounds. Failure to properly clean the bonding surface will result in ineffective bonding with adhesives.
3. Remove from the surface all obstacles that will prevent the heating mats from laying flat such as protruding nails, debris, or any item not fastened to or part of the surface.
4. Clean all surfaces of dirt and dust as per manufacturer's recommendations. If possible, power wash all surfaces. This will provide the cleanest and best bond with adhesives.

UNPREPARED SURFACE



Figure 2.1

PROPERLY PREPARED SURFACE



Figure 2.2

INSTALLATION - GUIDELINES TO FOLLOW

MATS SHOULD NOT OVERHANG MORE THAN 2 INCHES OVER EDGES, ROOFS OR GUTTERS.



DO NOT ALLOW MATS TO OVERLAP WHILE ENERGIZED.



TO PREVENT ICE DAMMING AND RUNOFF REFREEZING, MATS INSTALLED ON DRIP EDGES, NEAR DOWNSPOUTS, OR AT ENDS OF VALLEYS SHOULD BE INSTALLED WITHIN 1 INCH OF AN EDGE.



IF FASTENERS ARE NEEDED WHEN INSTALLING YOUR HEATED MATS, FOLLOW THE DIAGRAM BELOW FOR ACCEPTABLE PENETRATION AREAS

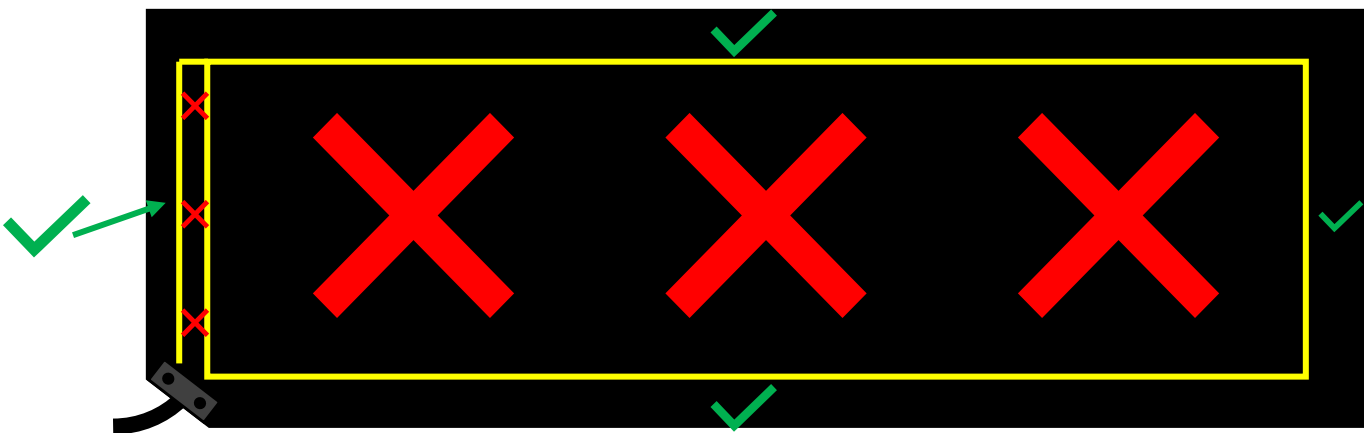

DO NOT PENETRATE MATS INSIDE OR WITHIN 1/2 INCH OF MARKED YELLOW LINES. THIS MAY CAUSE ELECTRICAL SHOCK OR GROUNDING OF THE SYSTEM

INSTALLATION - SYSTEM LAYOUT



PRIOR TO APPLYING ADHESIVE, ALWAYS LAY HEATING MATS OUT FIRST TO ENSURE A PROPER FIT AND CONFIGURATION. CONTACT TEMPURTECH IF MATS DO NOT FIT. DO NOT MODIFY THE MATS YOURSELF

TEMPURTECH MATS MAY BE INSTALLED WITH EITHER SIDE FACING UP

1. Follow Preparation Instructions (pg. 8) to completion. Application surface should resemble that shown below.



2. Unroll the mats and place them in their final positions. DO NOT apply adhesives until certain that the mat's size and configuration is correct for your application.

If you mat does not fit in the application area, contact Tempurtech at the listed phone number or email. DO NOT modify the mats yourself.



3. ADHESION

IF USING PRE-APPLIED TAPE:

a) With tape side down, fold mat along its length as shown. DO NOT CREASE

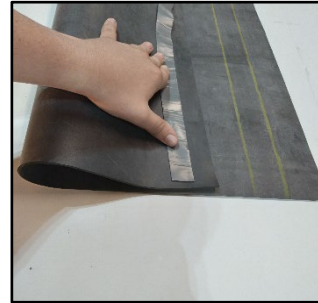

b) Slowly peel back film from a small section

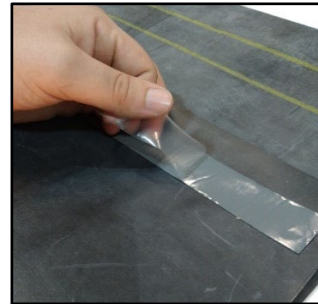

c) Press section firmly back into place. Repeat this process along the length of the mat, then repeat for other side.

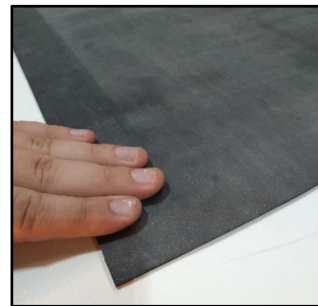

CONTINUED ON NEXT PAGE

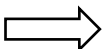

INSTALLATION - SYSTEM LAYOUT CONT'D

IF USING TAPE:

a) Clean surface of mat. Surface must be clean and dry. Moisture, dust, dirt or other foreign matter should be removed. Remove oil and grease, etc. with a small amount of non-residue cleaner such as acetone or lacquer thinner. Remove salt and other contaminants.

b) Apply the tape to the mat. Remove one side of the film from the tape and apply to the mat using hands or a roller in the shown

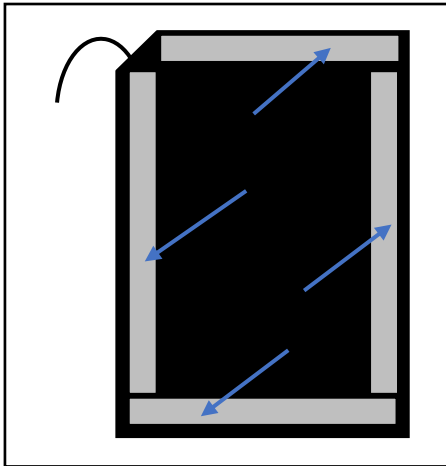

Apply tape within 1 inch of mat edges

c) Follow steps a), b), & c) in the "IF USING PRE-APPLIED TAPE" section (pg. 10) to complete the installation.

IF USING GLUE:

a) Fold half of the mat back on itself and apply EPDM primer around edges of the mat and surface of the application area to ensure the strongest hold. Apply according to primer manufacturer's instructions. **DO NOT CREASE MAT**

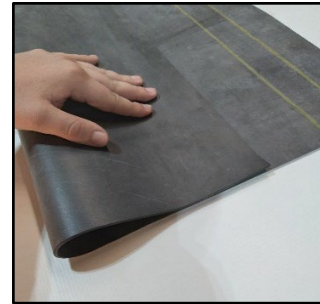

b) Brush on adhesive. Apply adhesive around edges of mat and on application surface. Apply according to adhesive manufacturer's instructions. Roll mat down

IF USING FUSE ADHESIVE:

a) Fold mat in half along its length as shown.

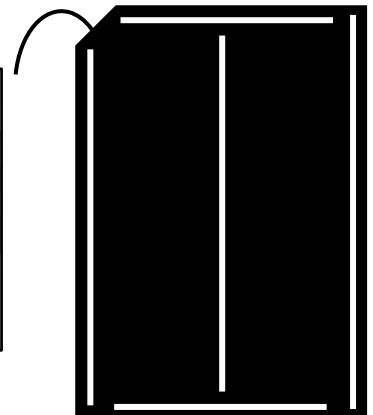
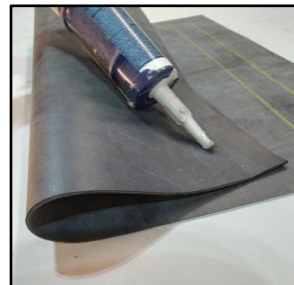

b) Apply adhesive along outer edges of the mat with a single line down the center as shown above. Apply adhesive according to adhesive manufacturer's instructions.

INSTALLATION - SYSTEM LAYOUT - GUTTERS

GUTTER MATS MAY BE INSTALLED WITHOUT ADHESIVES

1. Follow Preparation Instructions to completion. Application surface should resemble that shown below.



2. Unroll the mats and place them in the gutter, placing any heat trace cables in the appropriate downspouts. Mats should bend to fit the gutter's shape and should lay completely within the profile of the gutter.

If your mat does not fit in the gutter area, contact Tempurtech at the listed phone number or email. DO NOT modify the mats yourself.

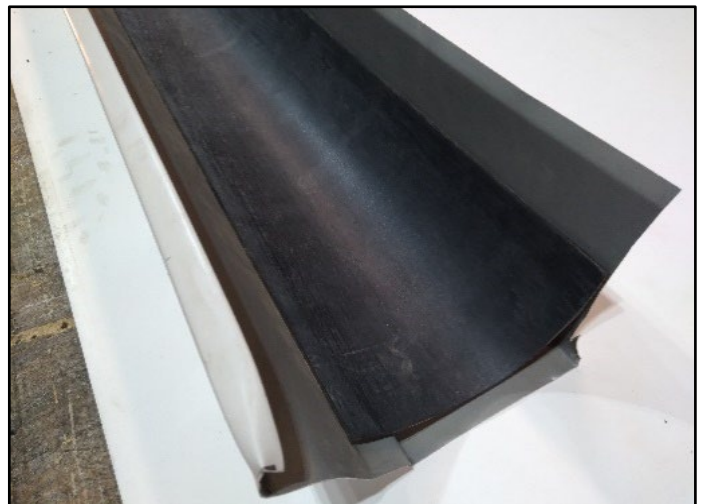
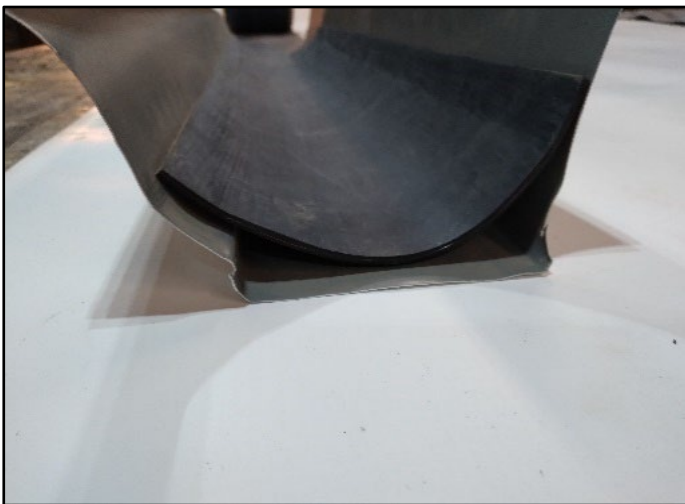

3. If choosing to use adhesives for the mats, refer to PAGE 10 "Adhesion" and follow steps for appropriate adhesive option. This is not necessary for most gutter installations.

INSTALLATION - ELECTRICAL



ELECTRICAL WORK SHOULD BE PERFORMED ONLY BY QUALIFIED AND COMPETENT PERSONNEL. FAILURE TO ADHERE MAY RESULT IN ELECTRICAL SHOCK AND PERSONAL INJURY.



CAUTION MUST BE TAKEN TO GUARD AGAINST RISK OF ELECTRIC SHOCK, FIRE, AND BODILY INJURY DURING INSTALLATION OF THIS PRODUCT.

TEMPURTECH HEATING SYSTEMS ARE MANUFACTURED COMPLETELY TO CUSTOMER REQUIREMENTS AND COME READY TO INSTALL. NO ADDITIONAL WIRING IS REQUIRED WITHIN THE SYSTEM EXCEPT TO SUPPLY POWER TO CIRCUITS/CONTROL UNITS.

DO NOT MODIFY JUMPERS, LEADS, OR MATS UNLESS AUTHORIZED BY A TEMPURTECH SALES REPRESENTATIVE.

Prior to installation please consult your local codes. If any of the information in this guide is not consistent with local codes, the local codes should be followed. Electrical wiring is required to be run from a circuit breaker or other electrical circuit to the heating mats or control. It is recommended that a qualified electrician perform these installation steps. Please be aware that local codes may require that this product and/or the control be installed by an electrician and inspected by an electrical inspector.

1. Determine Requirements. No system circuit will draw more than 16A. Size circuit breakers according to expected current draw for each circuit as outlined in "SYSTEM NOTES" on your system layout.

Circuits should not draw more than 80% of breaker capacity per NEC.

2. Per NEC Section 426.28 GFPE devices must be used on all fixed snow melting systems for equipment protection.

3. Connect leads for each circuit directly to power using an approved wiring method. If using a switch or other disconnecting means, follow instructions provided by manufacturer.

4. If using a DS-9C controller/CDP-2 control panel to control your system, consult "DS-9C User Manual" or "CDP-2 User Manual" for complete installation and operation instructions.

SAMPLE INSTALLS W/ CDP-2

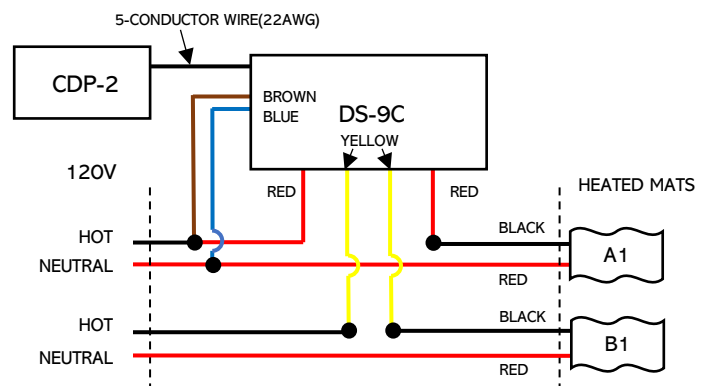
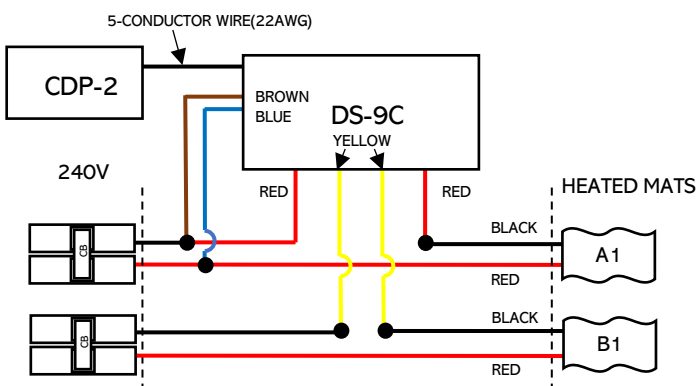

USER GUIDE - GET THE MOST OUT OF YOUR MATS



ALL ELECTRICAL OUTLETS USED TO SUPPLY POWER TO HEATING MATS MUST BE GROUND FAULT PROTECTED

IF USING A DS-9C OR DS-8C

In its recommended settings (Figure 3.1) your controller will activate and deactivate your heated mat system based on both temperature and precipitation conditions.

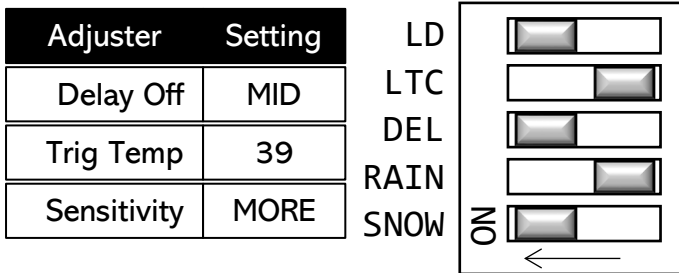

Figure 3.1: Recommended controller configuration

In most cases, the recommended settings will be sufficient for melting snow in an energy-efficient manner. However, these settings may be adjusted as needed. Please refer to your DS-9C or DS-8C user manual for information regarding preset adjustment.

If expecting snowfall or ice formation, ensure that your system is activated by checking to make sure there the green light is flashing on your controller.

NOTE: A steady green light means that there is power to the controller but the conditions for system activation have not

The controller may be activated manually by flipping the exterior toggle switch to the "Manual On" position.

IF NOT USING A CONTROLLER

When expecting snowfall or ice formation, turn your mats on ahead of time in order to ensure that they are at their maximum melting temperature. This will help the mats to stay ahead of the precipitation and prevent accumulation.

Tempurtech heated mats are intended to melt snow and ice instantaneously as it falls. If snow or ice is allowed to accumulate over the mats, it may impact the mats' effectiveness and ability to melt snow and ice.

NOTE: If you notice excessive snow built up over any mat, the snow may need to be removed in order for the mat to function properly again. Even though the mat may be working underneath, snow cavitation may be preventing it from melting through upper layers of snow.

During cool or cold weather, your mats may be kept on indefinitely. The mats' maximum heating temperature is 120°F, they will not heat above this limit, regardless of how long they are kept on.



DO NOT ACTIVATE OR LEAVE MATS ON DURING WARM/HOT WEATHER IF INSTALLED UNDERNEATH A ROOF. THIS MAY DAMAGE OR DESTROY THE MATS

TROUBLESHOOTING

<p>SYSTEM DOES NOT TURN ON</p>	<p>Check that the circuit breaker is on If you have a controller, check that the green light is on or flashing Check that the Ground Fault Protection is not tripped for each circuit Check wiring for each circuit</p>
<p>CAN'T FEEL ANY HEAT</p>	<p>Confirm that the controller is on and that the temperature threshold is not too low (DS-9C Installation Manual) Check the temperature set point on controller Mats may operate at cooler temperatures in cold weather. This is normal for operation</p>
<p>GROUND FAULT PROTECTION TRIPPING</p>	<p>Tripping is often caused by moisture in loose wire connections Double check circuit continuity & continuity to ground Check for loose connections and accidental grounding in wiring Check mat for incorrect penetrations or delamination</p>
<p>HEAT WORKS, BUT THEN SHUTS OFF</p>	<p>Check the controller temperature threshold setting Ensure that the moisture and temperature sensors are in appropriate locations (DS-9C Installation Manual)</p>
<p>MATS IMMEDIATELY TRIP BREAKER</p>	<p>Ensure that your mats are correctly wired according to your wiring diagram and this installation guide Check that your breaker is sized correctly for the mat Check mat for incorrect penetrations or delamination</p>

PLEASE NOTE THAT THIS IS A TROUBLESHOOTING DOCUMENT. IF YOU ARE NOT QUALIFIED TO DO ELECTRICAL WORK, IT IS RECOMMENDED THAT YOU HIRE A QUALIFIED, LICENSED ELECTRICIAN. ANY TROUBLESHOOTING WORK SHOULD BE DONE WITH THE POWER REMOVED FROM THE CIRCUITS UNLESS OTHERWISE INDICATED. IF YOUR PROBLEM CANNOT BE RESOLVED WITH THESE TIPS, CALL TEMPURTECH AT THE LISTED PHONE NUMBER. THESE TIPS ARE PROVIDED TO ASSIST WITH TROUBLESHOOTING THE HEATING MAT SYSTEM. RESULTS ARE NOT GUARANTEED. TEMPURTECH DOES NOT ASSUME ANY LIABILITY OR RESPONSIBILITY FOR DAMAGE OR INJURY THAT MAY OCCUR FROM USING THESE TIPS. REFER TO THE INSTALLATION GUIDE OR OTHER APPROPRIATE INSTRUCTIONS AND WARNINGS REGARDING INSTALLATION, USE, AND MAINTENANCE.

